

STEALTH 6

ULTRA

**ALL-IN ONE AMPLIFIED SOUNDBAR
USER MANUAL**



wetsounds.com

PASSION. PERFORMANCE. RUGGED FOR THE GREAT OUTDOORS!

Thank you for choosing Wet Sounds for your high performance Audio system! We build every product with Unsurpassed PASSION so we can deliver the HIGHEST PERFORMING Products to you! We live and breathe high performance audio. So you can enjoy the very best system options available for your vehicle.

The STEALTH ULTRA Series Sound bars are designed to give every owner of a Boat, UTV, Golf Cart and virtually any vehicle the ability to add high performance Audio in a SIMPLE to use design. Made for the great outdoors the STEALTH ULTRA Series Sound Bars are designed to be simple & easy audio options for your vehicle. **The STEALTH ULTRA Sound Bars are the true High Performance 2-wire 12 Volt stealth audio system!**

We appreciate your passion for great audio! Thank you for choosing Wet Sounds for your high performance audio needs.

For further questions, please call 1-877-938-7757 or visit www.wetsounds.com

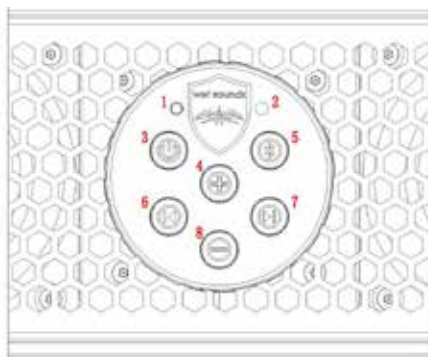

1. Reset

- If needed, press to reset sound bar for bluetooth pairing

2. Source Indicator Light

- Blinking Blue – Pairing Mode
- Blue – Bluetooth
- No Light – Aux

3. Power – Play/Pause – Mute

- Press and Hold For 3-5 Seconds to turn the unit on or off
- When Source Is Selected On Bluetooth, Press For Pause/Play Function
- When Source Is Selected On Auxiliary Input, Press To Mute Audio/ Un-Mute Audio

4. Volume Up

- Turns the volume up

5. Source Select

- Toggle between Bluetooth and Auxiliary input (3.5mm)

6. Track Back

- Skip to previous track

7. Track Forward

- Skip to next track

8. Volume Down

- Turns the volume down

INSTRUCTIONS FOR USING THE UNIT.

Press and hold the power button for 3-5 Seconds to turn the unit on.

Next, select what source you want to listen to, either Bluetooth or Auxiliary input.

Pairing with Bluetooth is easy, first press the source button on the unit until you see the source indicator light flash blue, next turn on your blue tooth device and search for WS-Stealth, then select it. That's it! You are now paired with the unit.

NOTICE: You can only pair one device to the unit at a time. If the unit is not blinking (indicating that it's in pairing mode) make sure that it's not connected to another device. If you are connected and want to pair another device, first you must go to the settings in your Bluetooth device and turn it off allowing the Stealth Ultra Soundbar to automatically search for new devices.

Some unique features on the STEALTH ULTRA Soundbar when playing your Bluetooth device, you can use the buttons on the sound bar to control your device by advancing tracks or replaying music on your device as well as volume. Also, by pressing the power button on the unit it will pause your music on your device and by pressing it again it will allow the device to continue playing. When the unit is selected in Auxiliary mode and the power button is pressed, the unit will mute the audio and un-mute the audio when pressed again.

When you are finished listening to music, simply press the power button and hold for 3-5 seconds and the unit will turn off. If the unit does not sense a signal from either the blue tooth or auxiliary input for 10 minutes, it will automatically turn itself off.

INSTALLATION

A. Mounting

1. Fit the appropriate tube clamp around the front strut in the desired location. ***Note: you may need to remove bolts connecting the top to the front strut to complete this step.**
2. If a sliding adapter was supplied in your kit, you will need to loosely fasten it to the soundbar, and then to the round tube clamps installed in step 1.
3. Ensure that the sound bar is in the desired location, then tighten all hardware.

B. Wiring

1. **If installing on an electric vehicle**, switch it into TOW mode. Carefully remove the Positive (+) then Negative (-) battery wires.
2. **A. If installing on a gas vehicle**, wire the Negative (Black) wire to the Negative (-) battery terminal and the Positive (Red) wire to the Positive (+) battery terminal.
B. If installing on an electric vehicle, wire the Negative (Black) wire to the Ground on the DC-DC Converter and the Positive (Red) wire to the Positive (+) post on the DC-DC Converter.
3. Route the blue Aux wires to your desired location.
4. Tie up all excess wires and reinstall the Positive (+) then Negative (-) battery wires. If installing on an electric vehicle, switch it back into RUN mode.

Note: DC-DC Converter is required on electric vehicles to avoid damage to the accessory and the vehicle.

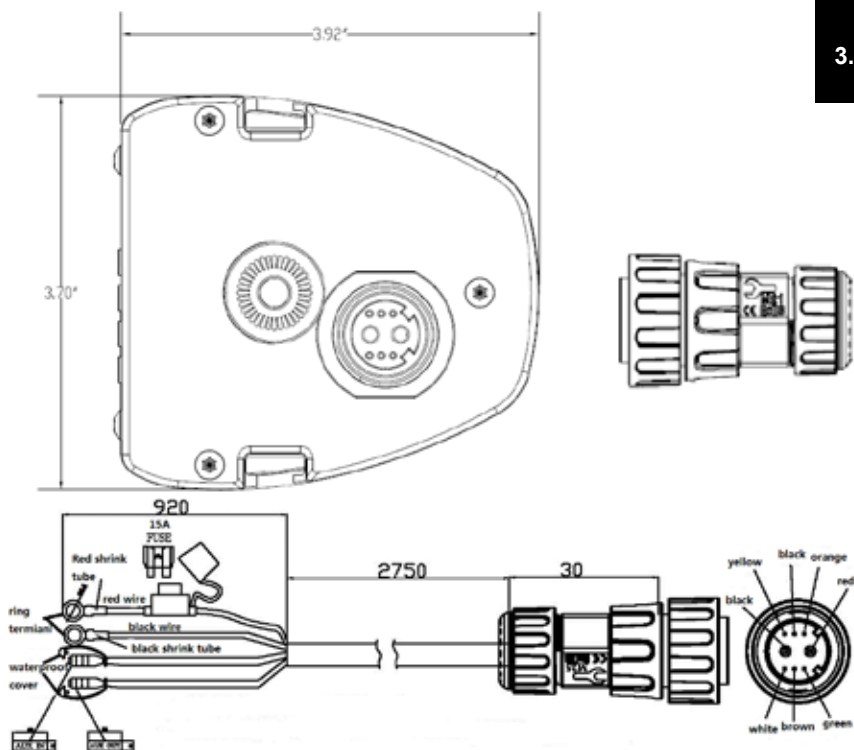

Wet Sounds STEALTH ULTRA
Sound Bars are an operating voltage of 12 volts

Weight - 13 lbs

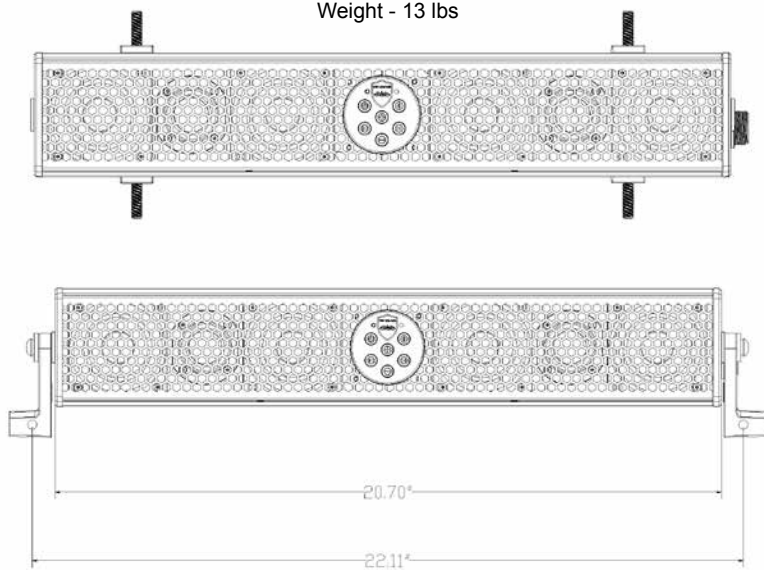

What This Warranty Covers

This is a "Limited" warranty. This warranty covers any defects in materials and workmanship and warranty only applies to the original purchaser and is not transferable. This warranty is also only valid if the original purchase was made from an authorized Wet Sounds™ dealer.

How Long Coverage Lasts

This warranty runs for 2 years from the date of the purchase. It is recommended to REGISTER your warranty online within 45 days of your purchase at www.wetsounds.com – click on "warranty registration".

What Is Not Covered

This warranty does not cover fading or discoloration caused by exposure to sun-light or chemicals such as ammonia, household bleach, or any cleaning material that contains abrasive substances. (For information on how to prevent fading or discoloration, consult for recommendations on cleaning products) Wet Sounds, Inc. does not cover the cost for removal and reinstallation of any kind. Additionally, shipping TO Wet Sounds, Inc. is covered by the purchaser This warranty is void and inapplicable if Wet Sounds™ deems that the product was abused or misused; including but not limited to Speaker product that has been improperly-powered (under or over powered), causing thermal (burnt voice coil) and/or mechanical failure (torn surrounds or spiders), damage caused by accident, mishandling, improper installation, negligence, normal wear and tear, excessive water or heat damage, freight damage or products that have been altered in any way. Product owned by anyone other than the original purchaser from an authorized Wet Sounds dealer. (The warranty is not transferable and will not apply to products purchased from unauthorized dealers.) Wet Sounds is not responsible for any damages to a consumer's boat or person from a product failure. The warranty is void if Wet Sounds deems the product was installed or used improperly. Wet Sounds shall not be responsible for any incidental or consequential damages, except to the extent provided (or prohibited) by applicable law. This warranty

gives you specific legal rights, and you may also have other rights which vary from state.

What Wet Sounds™, Inc. Will Do

Wet Sounds, Inc will repair any part of your product that proves to be defective in materials or workmanship. In the event repair is not possible, Wet Sounds, Inc will replace the product in question. If it is deemed necessary Wet Sounds, Inc. will either replace the entire product with a refurbished unit or it will be replaced with a model that is similar in price if that model is no longer available. Labor cost and materials needed to complete this service will be at no charge to the purchaser. Additionally, the cost of shipping TO the consumer is also covered under this warranty.

How to Obtain Warranty Service

Contact Wet Sounds, Inc. either by phone at 877-938-7757 or by email at warranty@wetsounds.com. A service representative will assist you in the necessary actions to verify that the problem that you are experiencing is covered under warranty. If it is in fact a warranty issue, Wet Sounds will issue an RA number for tracking purposes and give instructions on sending the product in for evaluation. Wet Sounds™, Inc. How State Law Applies This warranty gives you specific legal rights, and you may also have other rights which vary from state to state.

Internet Warning

Wet Sounds, Inc. products sold on any non authorized web site or internet auction site are void of any and all manufacturer's warranty. Please contact Wet Sounds™ at 877-938-7757 or visit our web site at www.wetsounds.com to search for an authorized site and/or an authorized retailer near you.

Caution & Respect

Wet Sounds™ speakers can achieve very high sound pressure levels. Please use this product responsibly. Be aware that sound travels great distances so please respect others. Wet Sounds, Inc. is not responsible for any violations of the law that may be a direct result of excessive volume. Please abide by the rules but have fun doing it.

Optional Accessories

Please visit www.wetsounds.com for more information

Stealth Clamp Square 1.25" (ST-ADP-SQ 1.25)

1.48" (L) x 0.79" (W) x 2.17" (H)

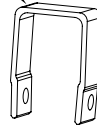

1.26" (W) x 1.26" (H)

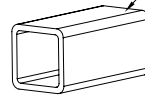

Stealth Clamp Square 1.0" (ST-ADP-SQ 1.0)

1.61" (L) x 0.79" (W) x 1.90" (H)



1.0" (W) x 1.0" (H)

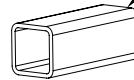

Stealth Clamp Square .75" (ST-ADP-SQ .75)

1.41" (L) x 0.79" (W) x 1.56" (H)



0.75" (W) x 0.75" (H)

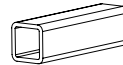

1.90" (L) x 0.79" (W) x 2.62" (H)

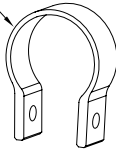

Ø1.75"

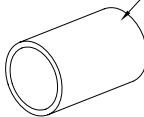

Stealth Clamp Round 1.75" (ST-ADP-SQ 1.75)

1.71" (L) x 0.79" (W) x 2.36" (H)

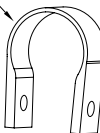

Ø1.50"

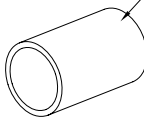

Stealth Clamp Round 1.5" (ST-ADP-SQ 1.5)

Stealth Adapter Side Bracket (ST-ADP-SIDE BRACKET)

2.48" (L) x 1.06" (W) x 1.36" (H)

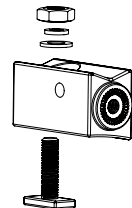
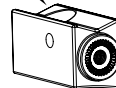



Wet Sounds Inc..
www.wetsounds.com
877-938-7757

9330 West Airport Blvd. Suite 170
Houston, TX 77031 - USA

